



Offset mulcher of high range with agricultural rotor, for works in agricultural margins, Banks, highways, channels, roads and others clears of public works for tractors between 120-180 HP. It incorporates safety system with springs. Angulation +90° / -50°. Rotor POLSER of 550°.

## CHARACTERISTICS

- ▶ Non-wear steel-plate chassis, thickness 10 mm.
- ▶ Rotor POLSER of Ø 550 mm.
- ▶ External gearbox SERRAT.
- ▶ 4 XPC side belt transmission.
- ▶ Supports of bearing rotor in steel.
- ▶ Height-adjustable rear roller Ø 210 mm.
- ▶ PTO 750 rpm.
- ▶ High speed and high strength bearings.
- ▶ Front protection curtain.
- ▶ Front skid shoes.
- ▶ Double bearing on rear roller.
- ▶ Angulation +90° / -50°.
- ▶ Hydraulic lateral offset mulcher.
- ▶ Safety valve.
- ▶ Model built under EC Normative.
- ▶ Safety indicators visible to personnel.



### Centre shaft with homocinetic knot



### Agricultural hammers model SERRAT

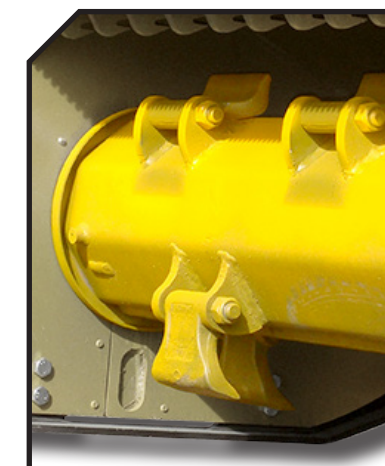

Angulation  
+90°

-50°





### Springs safety system

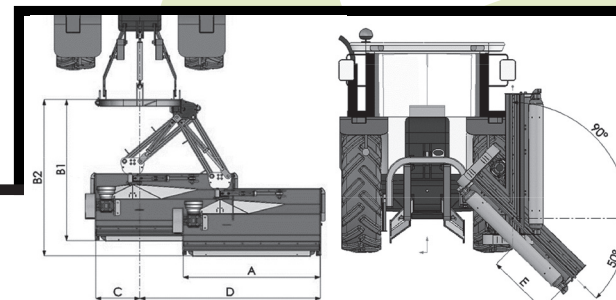

## OPTIONS

- ▶ Internal gearbox



MODEL	 mm	 KW-HP.		 KG	Nº BELTS TYPE	A mm-in	B1 mm-in	B2 mm-in	C mm-in	D mm-in	E mm-in	
T-1800	1800	89 - 120 127 - 170	16	1635	4 XPC	2380-94"	2540-100"	2875-113"	190-17"	2825-115"	725-29"	750
T-2000	2000	97 - 130 127 - 170	16	1685	4 XPC	2580-102"	2540-100"	2875-113"	190-17"	3025-119"	925-36"	750
T-2300	2300	104 - 140 134 - 180	20	1710	4 XPC	2880-113"	2540-100"	2875-113"	190-17"	3325-131"	1225-48"	750
T-2500	2500	112 - 150 134 - 180	20	1815	4 XPC	3080-121"	2540-100"	2875-113"	190-17"	3525-139"	1425-56"	750

